

ZHG-10

REV	POSITION	DATE	DESCRIPTION

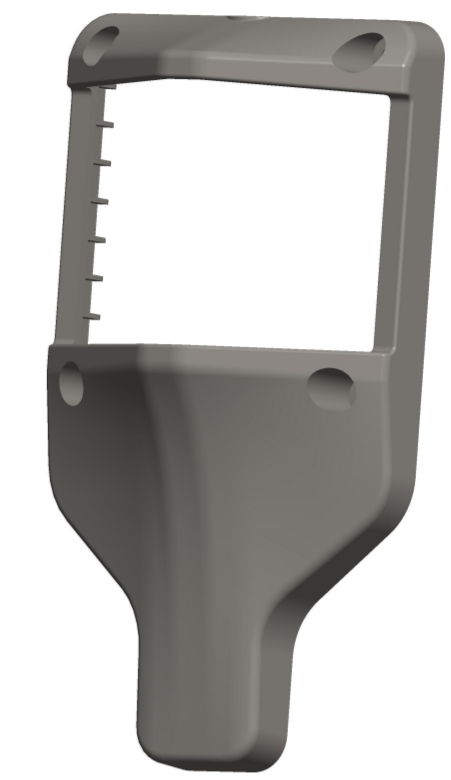

比例 1:2

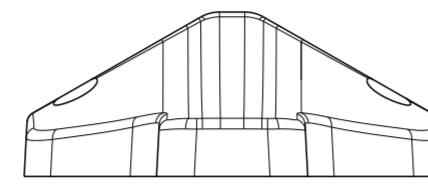
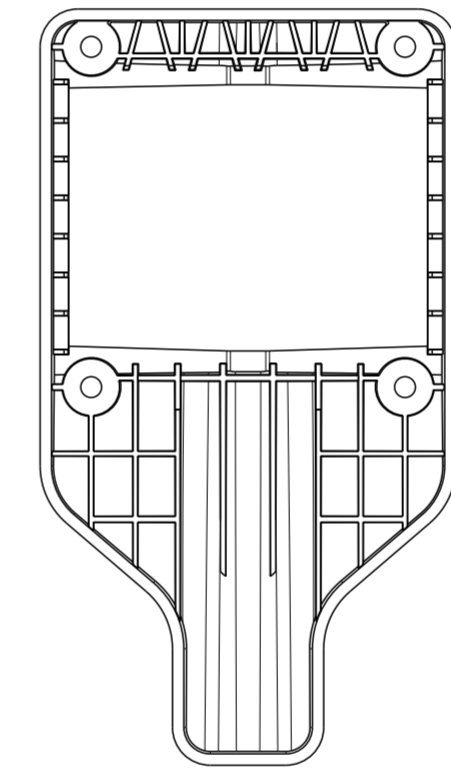
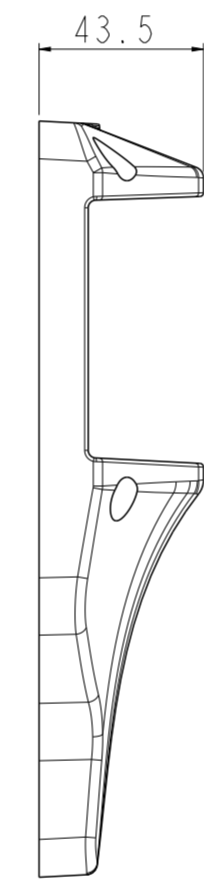
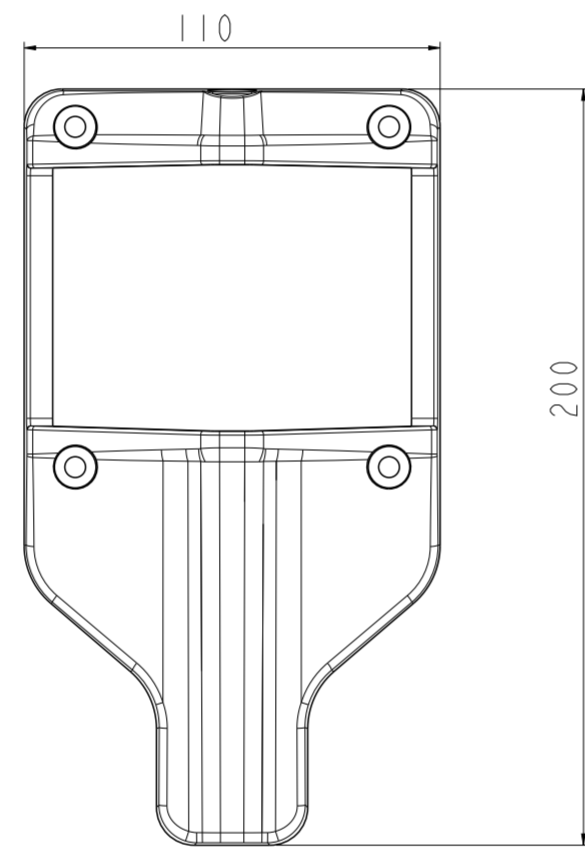
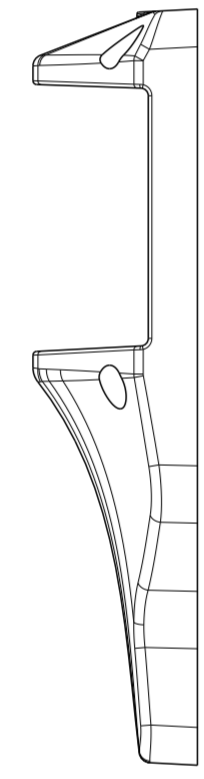

比例 1:2

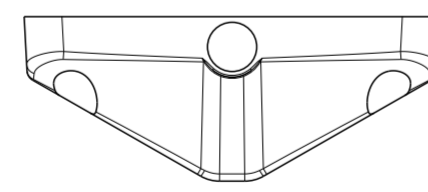

±TOL				AUTEL 深圳市道通智能汽车有限公司 Autel Intelligent Automobile Corp., Ltd.		TITLE:	
DIM	Plastic	Sheetmetal	Machining	These Drawings And Specification Are The Property Of AUTEL. And Shall NOT Be Reproduced Copied Or Used In Any Manner Without The Prior Written Consent Of AUTEL.	DRAW:	UNIT'S:	DWG NO.:
0-30	0.20	0.15	0.10		CHKD:	mm	01-BHZ
30-120	0.35	0.25	0.15		STAD:	FINISH:	PART NO.:
120-300	0.65	0.35	0.20		APPD:	SCALE:	REV
300-600	1.10	0.50	0.25		PROJ	1:1	
600-1200	1.75	0.60	0.30		SHEET: OF	PRODUCT:	MATERIAL:
>1200	2.10	0.80	0.50				
ANG	/	°	30'				

RELEASE LEVEL: 1
FILE NAME: 01-BHZ